

PRODUCT SHEET

Description:

Shoe Boy, 1 Opening, White PS, Left Hand, No Fittings

Item number:

22.07.206-0

Units	Box	Carton	HS Code	Barcode
Pcs.	1	200	3926300090	 5704866081771

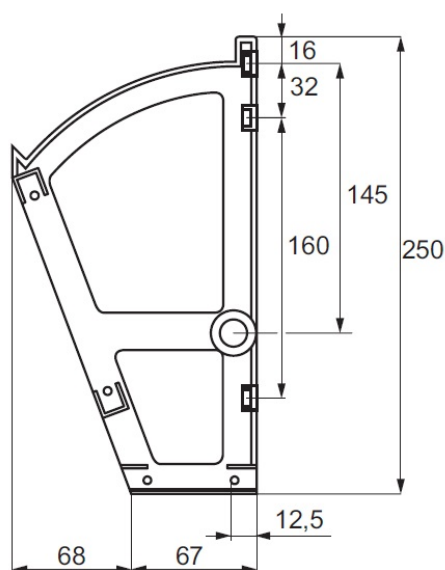

SISO A/S

Mileparken 11
DK-2740 Skovlunde
Denmark
VAT: DK 24786013

Phone +45 45 830 900

www.siso.dk
siso@siso.dk

Danske Bank
Nytorv Branch
Copenhagen
SWIFT: DABADKKK

Account no.
4180 3112 112936
IBAN Account
DK7230003112112936